

the **e** senses

e-Sense **Move Highbay**

**FAGERHULT**

## Page Content

The Basic Function of Move Highbay.....	4
Programming Connection Between Move Sensors.....	5-7
Erase Connection Between Move Sensors.....	8
Pre-set Scenes.....	8
Program Personal Settings .....	9-10
Receiving RF-signal Options.....	11
Reduced Power, Standby Dimming Level.....	12
Hold Time, Standby Time.....	13
On/Off, Auto Mode .....	14
Lux Threshold .....	15
Test Button, Brightness, Test Function .....	16
Dual Sensor Technology.....	17
Detection Range/Sensitivity .....	18
Wiring example .....	19

## **Luminaire with built in dual Microwave and PIR sensor**

The dual sensor permits the user to switch between microwave or PIR presence detection or use both. A Microwave sensor can detect movement through thin physical constructions, such as doors, and the sensitivity can be easily adjusted. However, in applications where luminaires are situated near non-static technology, such as air ventilation systems which can activate detection via their vibration, the PIR functionality is specifically relevant. The ability to alternate within the same fitting offers unparalleled flexibility should layout or use of the space change over time.

**Bandwidth:** 868 MHz

**Coding Technology:** KeeLoq

**Number of learning codes/sensor:** 15 pcs

**Max RF-distance between two sensors:** 40 m (open air)

**Programming tool:** Fagerhult IR Remote control FRC-11, article number 86368 (batteries included)

**Distance between IR Remote control and sensor:** Max 10 m

**Load communication protocol:** DALI Broadcast



## How to Program Connection Between Move Sensors

The communication for Move sensors is based on a simple basic “handshake” setup between two or more units.

First, one (or more) sensor is set to LEARN. This will be indicated by the sensor blinking red once per second.

Tip! Switch off the luminaires with the ON / OFF button to make sure that the sensor is in LEARN mode. After programming, the system returns to operation when you press the AUTO MODE button.

Now go to the next sensor, whose signal the first one will learn. Press the SEND button. The connection will be indicated by a rapid blinking from the first sensor in LEARN mode. After this, the sensor goes back to slow blinking waiting to see if it should learn another signal. You can now add more sensors/luminaires by following the same principle. If the system is finished, press LEARN until the blinking stops and your system is now closed.

Now do it the other way around so the sensors can communicate in both ways depending on which one is detecting movement first.

On next pages this is explained step by step.

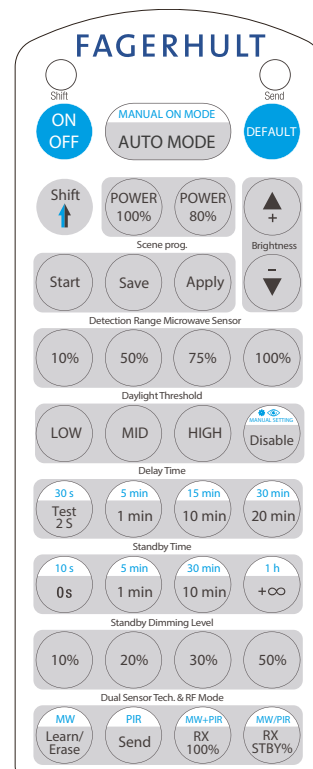
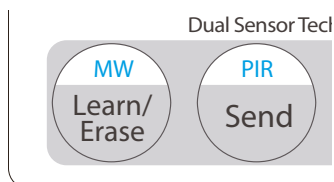

## How to Program Connection Between Move Sensors

### Sensor 2 will Listen to Sensor 1

Aim the IR-remote carefully to fixture 2 and press LEARN.

The sensor will start to blink every second, prepared for receiving signals from other sensors. The sensor will remain in this mode for 3 minutes if not cancelled manually.

Now aim the IR-remote carefully to fixture 1 and press SEND. Sensor 2 will blink rapidly for 2 seconds to confirm the received signal. Now it is possible to go to sensor 3 and do the same procedure. The result is that sensor 2 will turn on the light by presence from either 1 or 3.

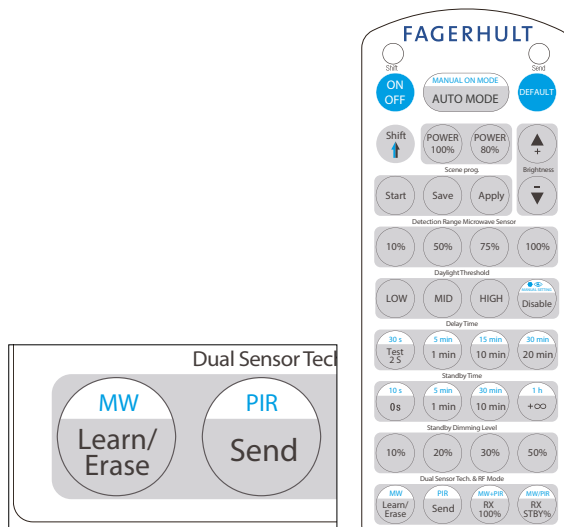

### Learn

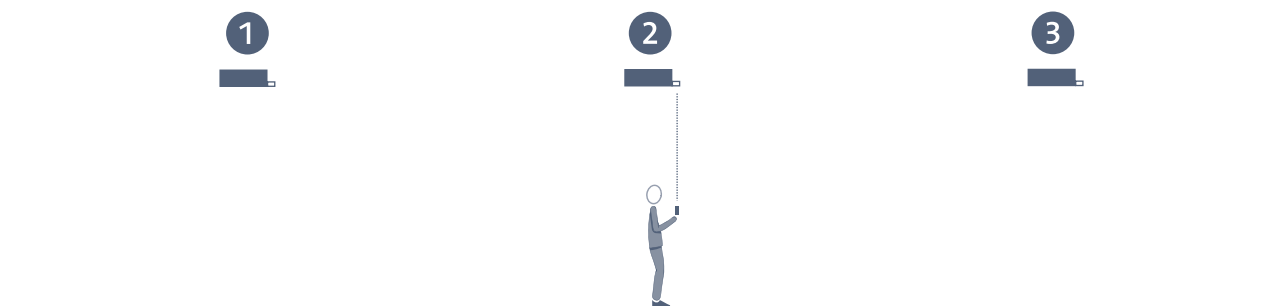

### Send

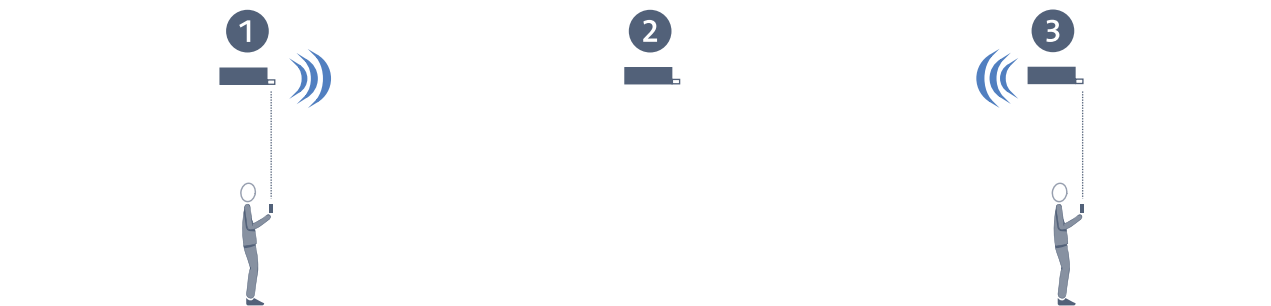

## How to Program Connection Between Move Sensors

### Sensor 1 and 3 will Listen to Sensor 2

Aim the IR-remote carefully to fixture 1 and 3 and press LEARN. The sensors will start to blink every second, prepared for receiving signals from other sensors. The sensors will remain in this mode for 3 minutes if not cancelled manually.

Now aim the IR-remote carefully to fixture 2 and press SEND. Sensor 1 and 3 will blink rapidly for 2 seconds to confirm the received signal.

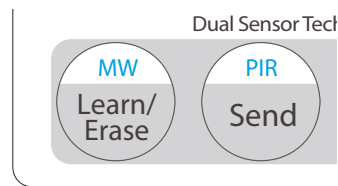
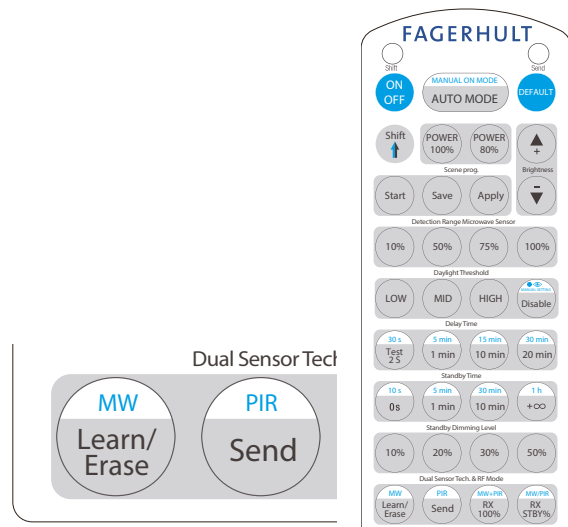

### Learn

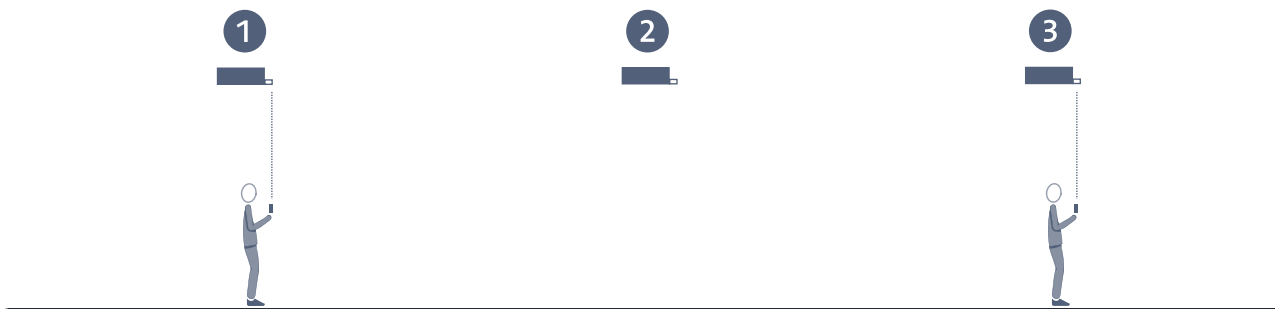

### Send

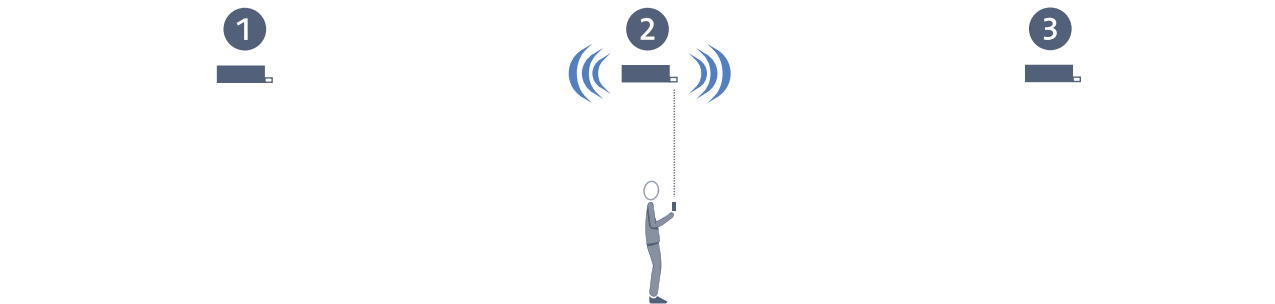

With this programming done, each sensor will always send signals to the next one to turn light on.

## How to Erase Connection Between Move Sensors

It is possible to erase a sensor from listening to RF-signals from other sensors.

Use the LEARN/ERASE button on the IR-remote control. Aim the remote to the sensor/fixture that shall be excluded from communicating with other sensors. Press LEARN/ERASE button for 10 seconds. During this sequence, the sensor will blink once a second. When the resetting is done, the sensor blinks rapidly to confirm the programming.

*Note! This Erase function will only stop the RF communication between sensors. It will not affect the setting of any other function.*

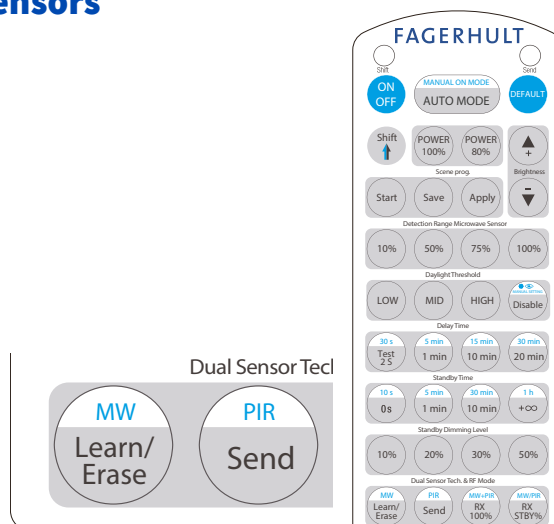

### Learn/Erase

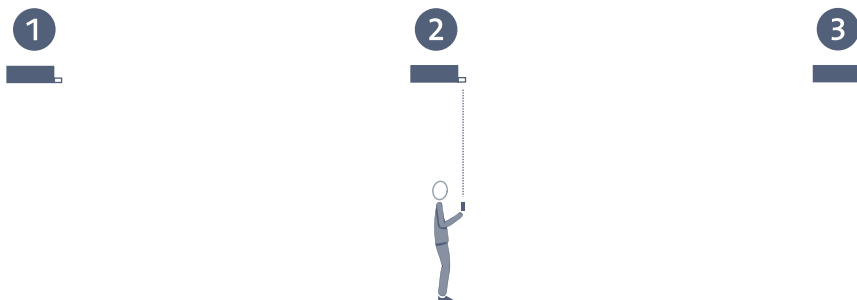

### Default setting of the sensor

On delivery, the sensor has a standard setting that is also very easy to use as start for the installation. The default settings are:

- Delay time: 1 min.
- Standby time: 5 min.
- Standby dimming level: 20 %
- Daylight Threshold: Disabled
- RF signal STBY %: 100 %
- Sensor active: PIR (Microwave disabled)

Whatever settings that have been done, it's easy to go back to Default by pressing the DEFAULT button. The luminaire will blink to confirm the received information.

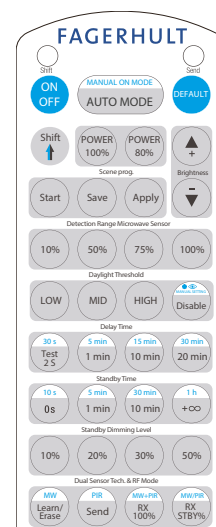



## Pre-set Scenes

It is possible to download all settings in the remote before transmitting the package to a sensor. Go through the steps as described below.

The settings that can be part of a package is:

- Detection range (micro wave Sensor only)
- Daylight Threshold
- Delay time (after last movement detected)
- Standby Time (time at dimmed low level)
- Standby dimming level (Low level before OFF)

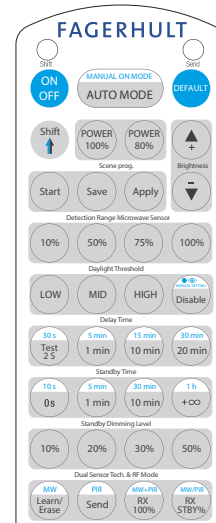

Press Start



Select Detection Range (If Microwave sensor is used).

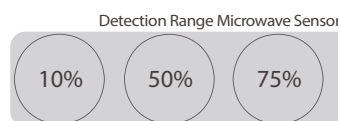

Select Daylight Threshold or Disable the function



Select Delay Time (use Shift Button to alternate to BLUE functions).



Select Standby Time (use Shift Button to alternate to Blue functions).

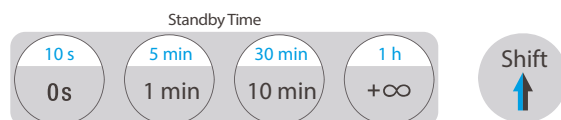

Select Standby Dimming Level.



Memory for saving settings. And use Apply to sensing information to sensor (The luminare will blink to confirm the received information.).

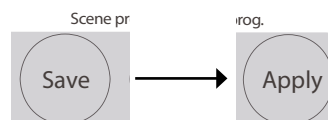

## How to Program Personal Settings

### Delay Time

Time after last presence detected. After time has elapsed, light will dim to Standby Dimming level.

### Standby Time

How long light will remain on low level before turning off. The off function can be avoided by selecting  $+\infty$  (infinity button).

### Standby Dimming Level

How bright the light will be during the Standby Period.

10, 20, 30 or 50 % light level can be selected.

### Daylight Threshold

If daylight is brighter than the set value, light will not turn on when presence is detected.

### RF-signal Standby %

When a sensor is detecting presence and sending an RF-signal to other sensors, the receiving sensor can be selected to go to 100 % light, or a standby level. 10, 20, 30 or 50 % can be selected. Select standby level (Rx STBY %) or full level (Rx 100 %).

### Detection Range for Microwave Sensor

Depending on height and setting, the detection range can be adjusted approx. between 16 m to 8 m. PIR sensor can be restricted by covering part of the lens.

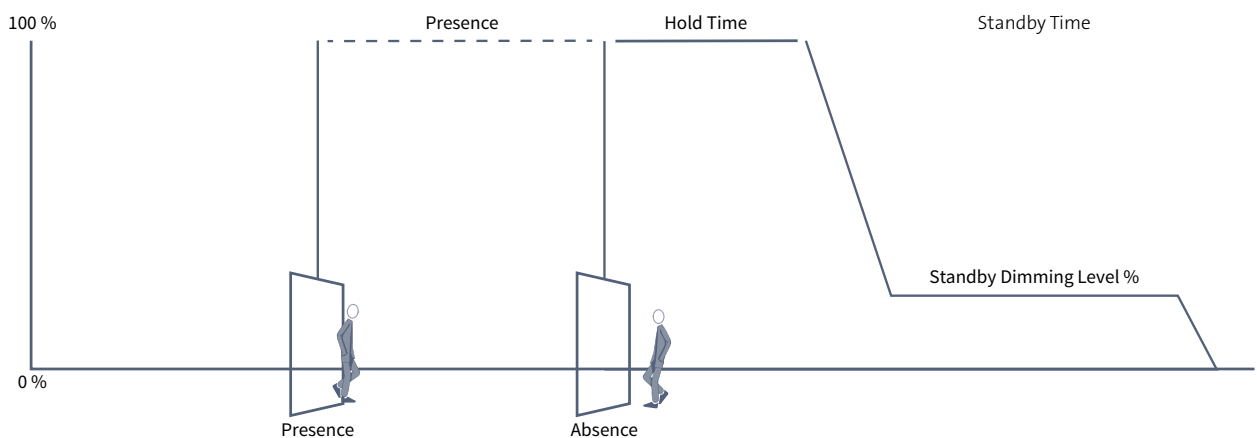

## Receiving an Rf-signal

When a sensor is detecting presence, and sends out the information, receiving units can act in two different ways upon the information. Light can go from OFF to 100 % (Rx 100%) or to a Standby Dimming Level (Rx STBY%). The Standby Dimming Level will be the same that is used after Delay Time has elapsed.

Sensor Receiving an RF-signal set to Rx STBY % and Standby Level 20 % When a signal is received by a sensor, light goes to 20 % and remains there for the Standby Period if nothing more happens. If presence is detected, light will go to 100 %.

After absence and Hold Time is elapsed, light will dim to 20 % and then OFF.

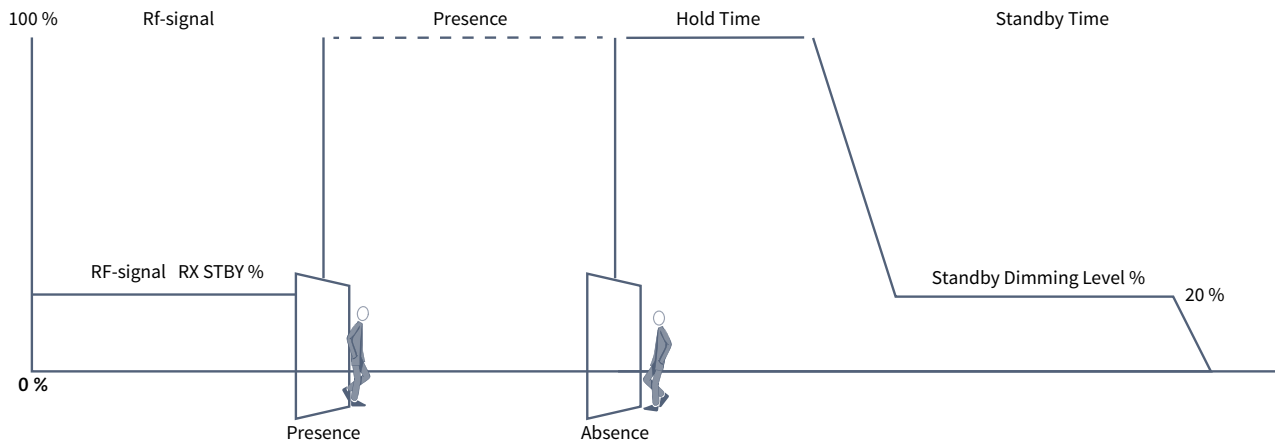
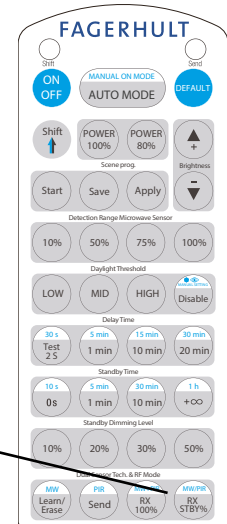
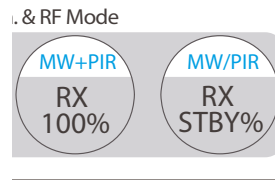

Sensor Receiving an RF-signal set to Rx 100% and Standby Level to 30%

When a signal is received by a sensor, light goes to 100% and remains there if nothing more happens. If presence is detected, light will remain at 100 %. After absence and Hold Time is elapsed, light will dim to 30 % and then OFF.

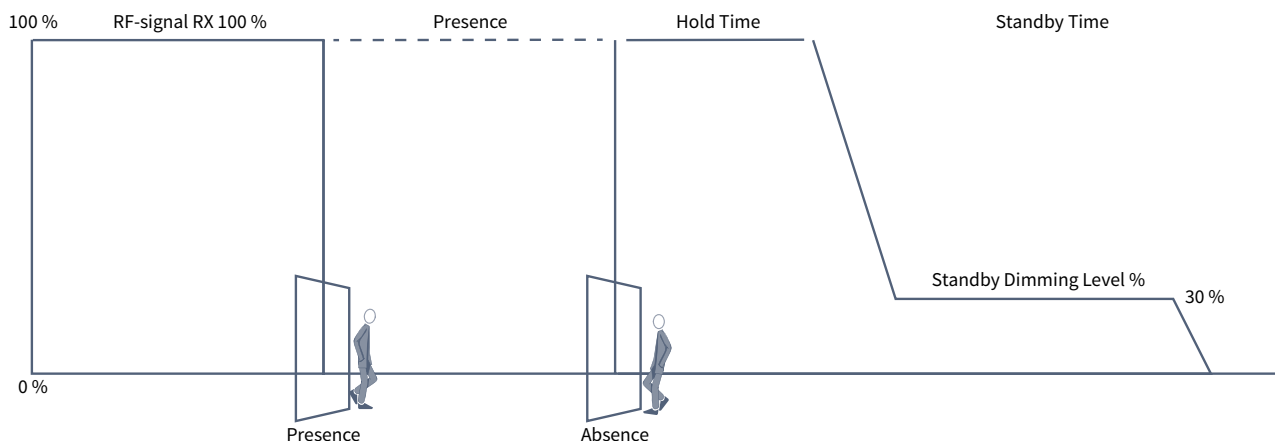

## Reduced Power

Default and normal use will give full light output 100 % at presence. But it is possible to reduce power by 20 %. This can be useful during a light fixtures first years of use, where the light output can be more than the estimated value. Return to 100 % by pressing Power 100 % button. This has to be made manually, no clock or calendar function is used.

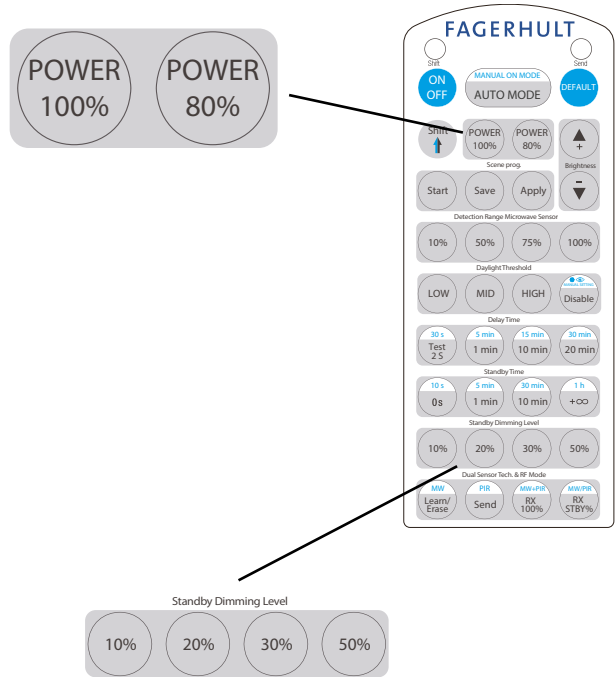

## Standby Dimming Level

Standby Dimming Level is setting the light output during Standby Time. This means that light can be set to a functional level during absence, with enough light for the surrounding area. More light can be used close to exists, stairwells, lifts etc.

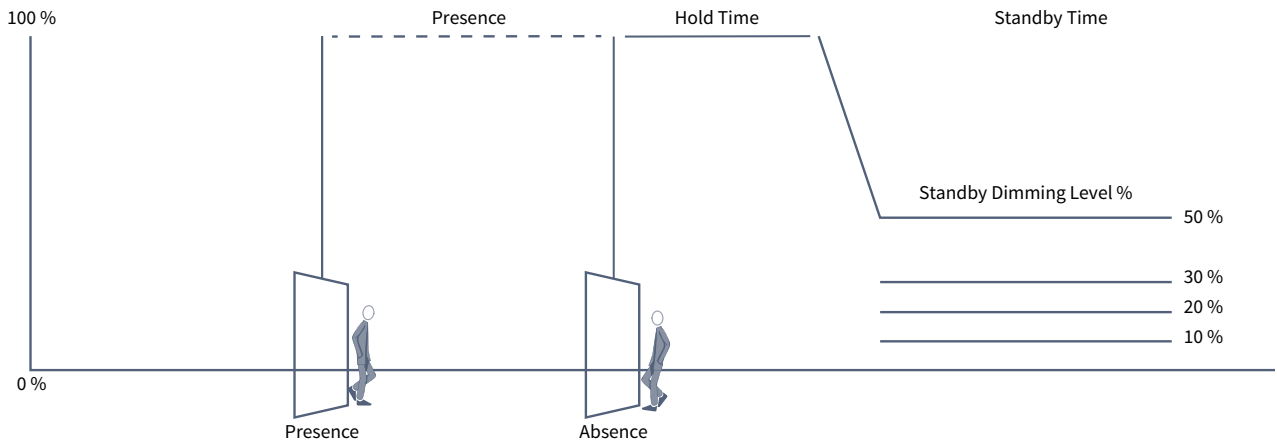

## Delay Time

Delay Time sets the time period that light should remain on 100 % after last presence detection. Depending on the light source, and location, the time can be set to very short (LED's) or longer for fluorescent tubes. A longer time can be used to avoid rapid on/off sequences, which can be irritating. Select values in blue by pressing the Shift button first. The TEST function is explained later in this document.

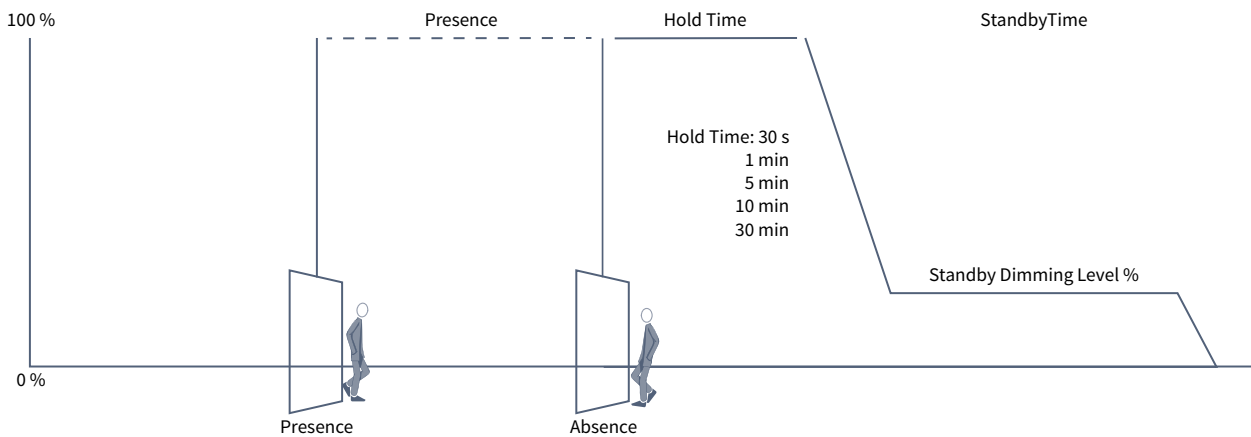
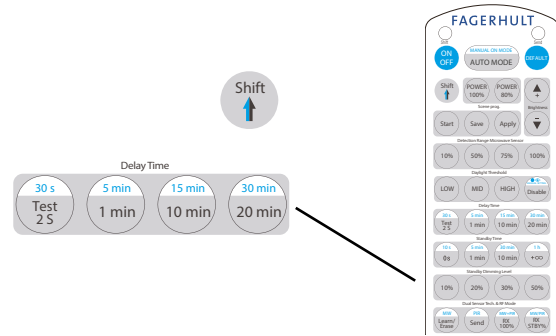

## Standby Time

Standby time sets the time for how long light should remain ON at Standby Dimming Level. After Delay Time, light can go directly to OFF (0 s), 10 s, 1 min, 5min, 10 min, 30 min, or remain ON without turning OFF at all +∞ (infinity button). Select values in blue by pressing the Shift button first.

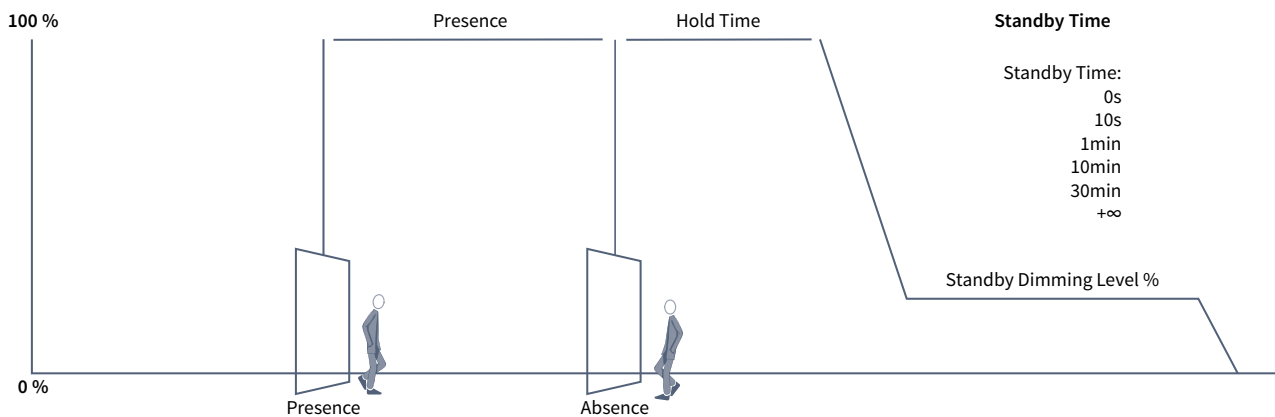
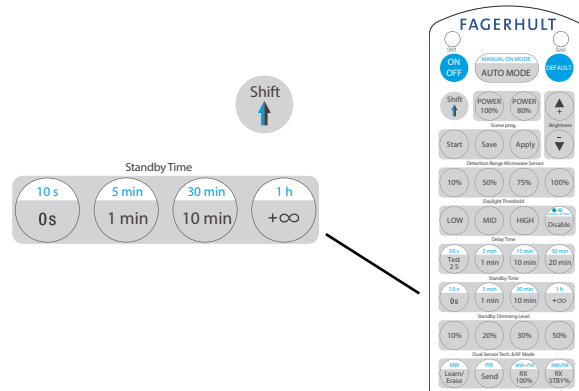

## ON/OFF Function Constant ON

Press once, and light will remain ON until other action is taken. This will leave light constantly ON at 100 %. Presence is muted. To leave this mode, press Auto Mode or DEFAULT button. Auto Mode will make the setting go back to previous programming. DEFAULT will return all settings to default.

*NOTE: A power failure will remove this function to previous setting (Auto Mode).*

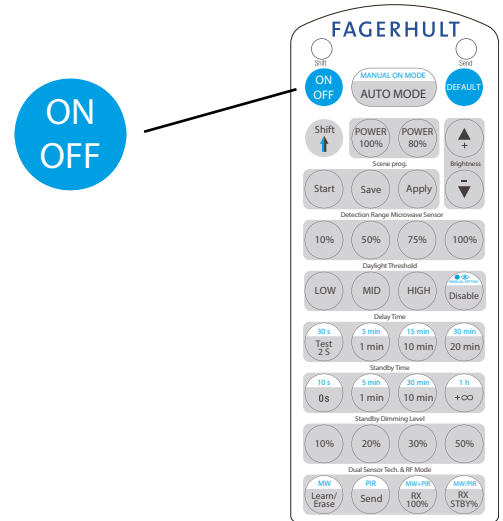

## ON/OFF Function Constant OFF

Press once more, and light will remain OFF until other action is taken. This will leave light constantly in OFF position. Presence is muted. To leave this mode, press Auto Mode or DEFAULT button. Auto Mode will make the setting go back to previous programming. DEFAULT will return all settings to default.

*NOTE: A power failure will remove this function to previous setting (Auto Mode).*

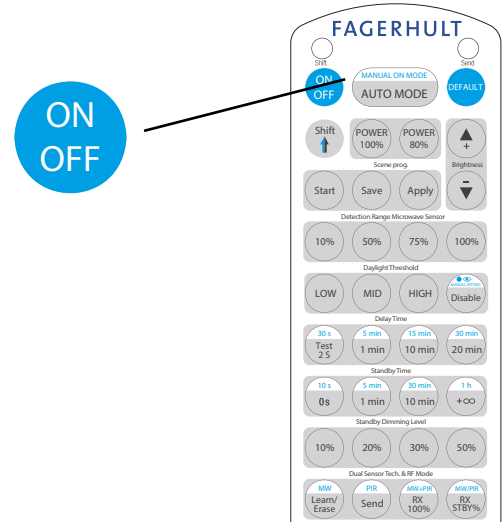

## Auto Mode

Press this button once to leave any state of the ON/OFF function. This will return the sensor to previous settings.

Note: Manual on mode is disabled.

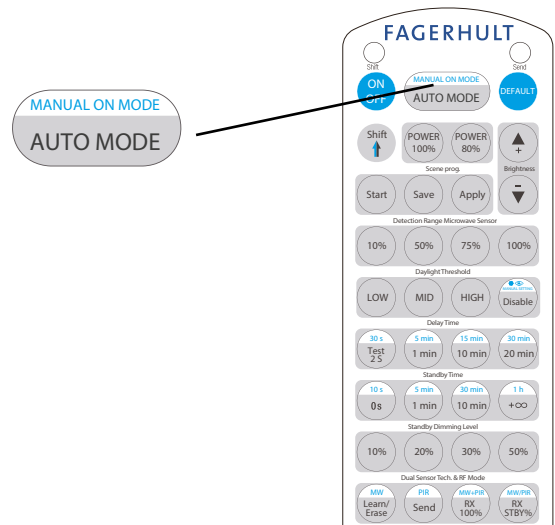

## Lux Threshold

A Lux Threshold will save energy when there is no need for artificial light. The Lux sensor is reading through the fixture cover when light is off. If the set value of lux is already fulfilled with daylight, the presence detection is muted, and light will remain off. The RF-signal will still be sent out to other sensor that might be under their individual Lux Threshold setting. This will make the system very flexible. The detection of presence can be muted if there is already sufficient amount of daylight in the area. The settings are Manual, Low, Mid, High and Lux Disable.

## Manual Setting of Lux Threshold

This setting must be done on site at the actual moment when light should mute the sensor.

## Low Lux Threshold

With this level activated, the presence detection of the sensor will only work if the surrounding light level is more or less completely dark. Any light will mute the sensor.

## Mid Threshold

With this level activated, the presence detection of the sensor will be muted during daytime. For a more exact dusk or dawn setting, use the manual setting

## High Lux Threshold

With this level activated, the presence detection of the sensor will be muted during full effect of daylight. For a more exact dusk or dawn setting, use the manual setting.

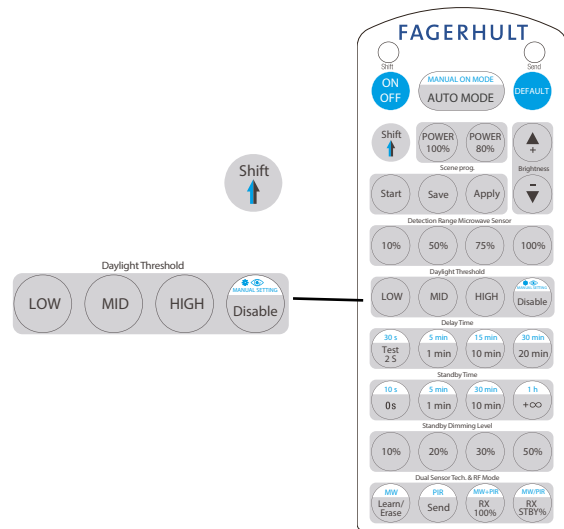

## Manual Learning Sequence

Press the “eye” button (press Shift button first). The sequence will start by turning the light off. During this period, the lux sensor will read and memorize the light level. This will then be used as a threshold for when the sensor shall act or be muted when detecting presence. More light than the set level; light will not turn ON. Less light, light will turn ON.

## Lux Disable

This setting lets the sensor work without any effect of surrounding daylight. The light will always turn on when presence is detected.



If surrounding light is HIGHER than the threshold setting. Presence will not turn lights on.

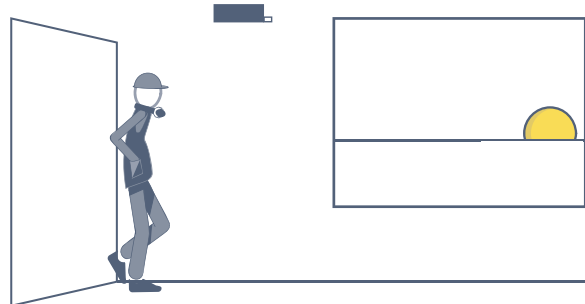

If surrounding light is LOWER than the threshold setting. Presence will turn lights on.

## Shift Button

The Shift Button will activate all functions in blue. When the shift function is active, the selected value can be sent directly to a sensor, or part of the Save/Apply procedure. The Shift function is active for 20 seconds after last selected value is pressed. The the remote will return back to normal status.

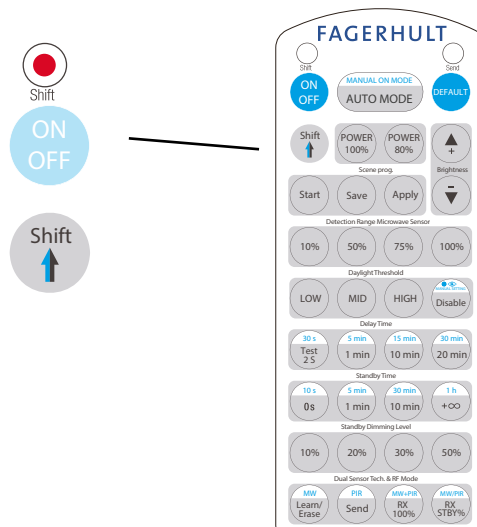

## Brightness

It is possible to temporarily adjust the light level between max – min, with the Brightness Buttons. To leave this mode, press Auto Mode or DEFAULT button. Auto Mode will make the setting go back to previous programming. DEFAULT will return all settings to default. Normally, these buttons are not used for e-Sense Move Highbay.

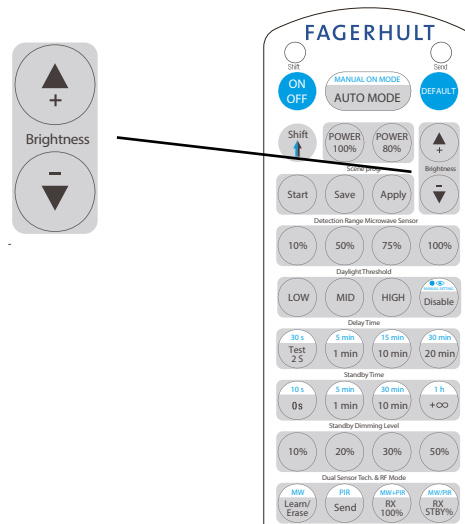

## Test Function

The TEST function is used for checking the sensors de-tection range. All other functions are temporarily muted. Light will dim down after 2 s. of absence, and go to 100% when presence is detected. For return to normal mode, select Auto Mode button or Default button.

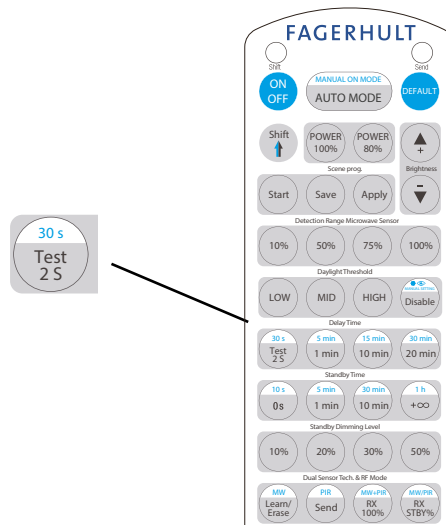



## Dual Sensor Technology

E-Sense MOVE High bay is equipped with both a PIR and a Microwave sensor. The sensors can be used one at a time or in a combination thereof.

PIR+MW: Light is ON when both sensors are activated

PIR/MW: Light is ON when PIR or MW is activated

PIR: PIR only

MW: Microwave only. Detection range can be adjusted.

Press the Shift button first, then select the sensor function that that will be in use. After a sensor is selected, it can take up 30 sec for it to “warm up” and operate normally.

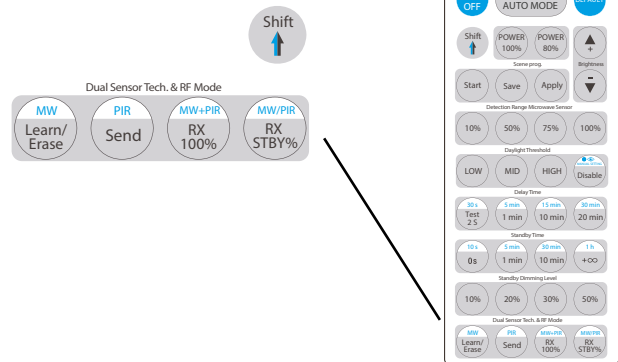

## Microwave and PIR sensor in combination

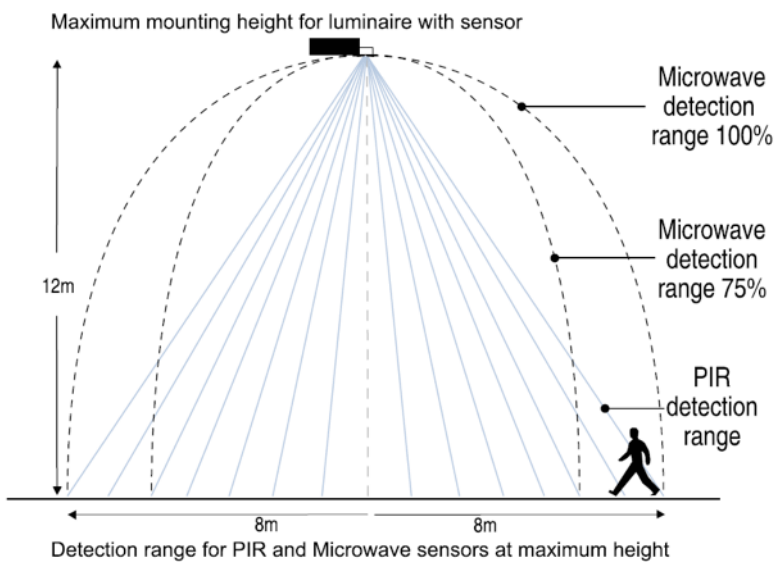

# Detection Range/Sensitivity

## PIR sensor

The two lenses for the PIR sensor will detect in two different patterns. The PIR sensor can not be set to detect more or less, but it is possible to mask the detection range by partly cover the lens.

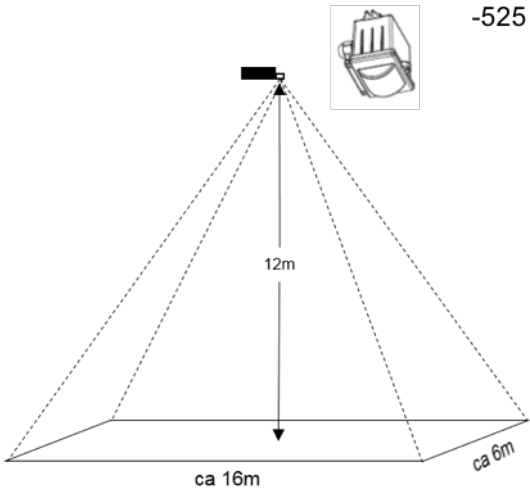
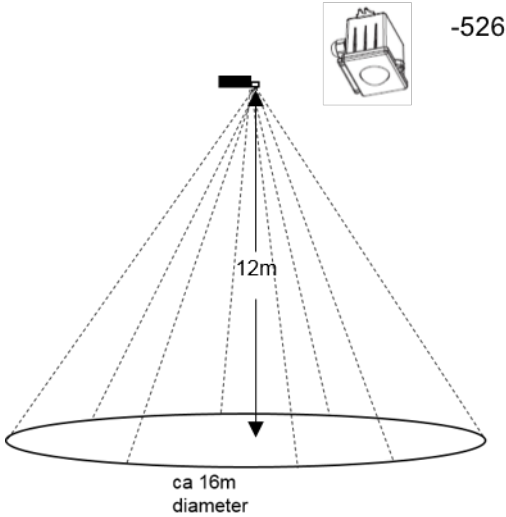

## Microwave sensor

The Microwave sensor acts different. It is possible to change the detection area by reducing the power output. It can be set to 100%, 75%, 50% and 10%. At 12m height, a 10% setting will not work, the detection “dome” will be too small.

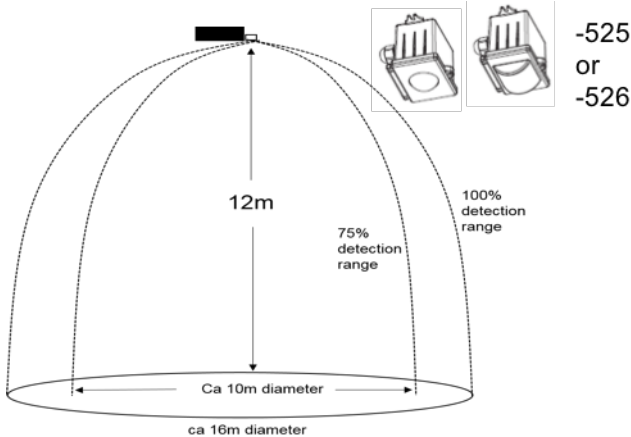

## Wiring example

### Stand alone with MOVE communication

Luminaires with sensor works as a stand alone unit that communicates wireless with other sensors. In this way all luminaires works as a Master/Slave depending on which sensor detects presence.

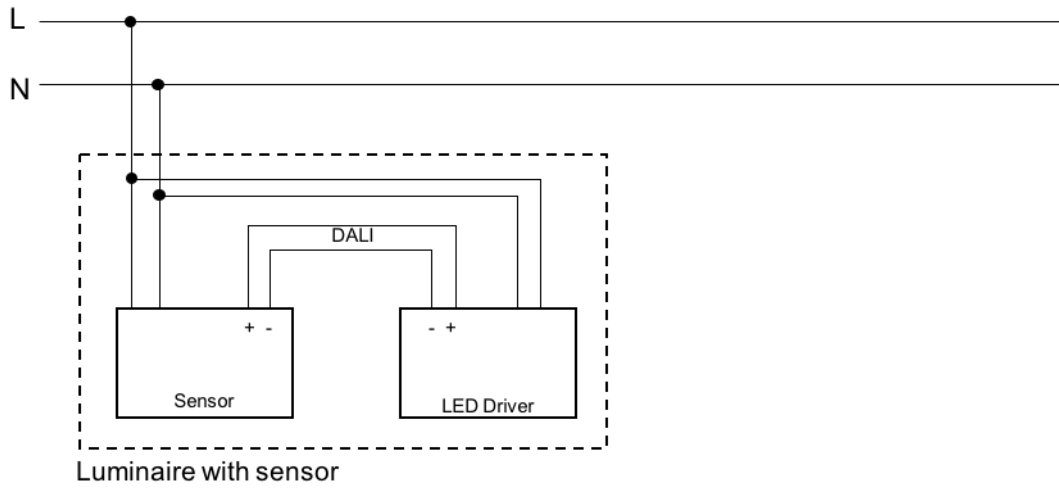

### Connection to slave DALI luminaire

Installation at maximum height does not need to have a sensor in every luminaire. DALI luminaires can be controlled from the MOVE High Bay luminaire. Maximum 20 pcs.

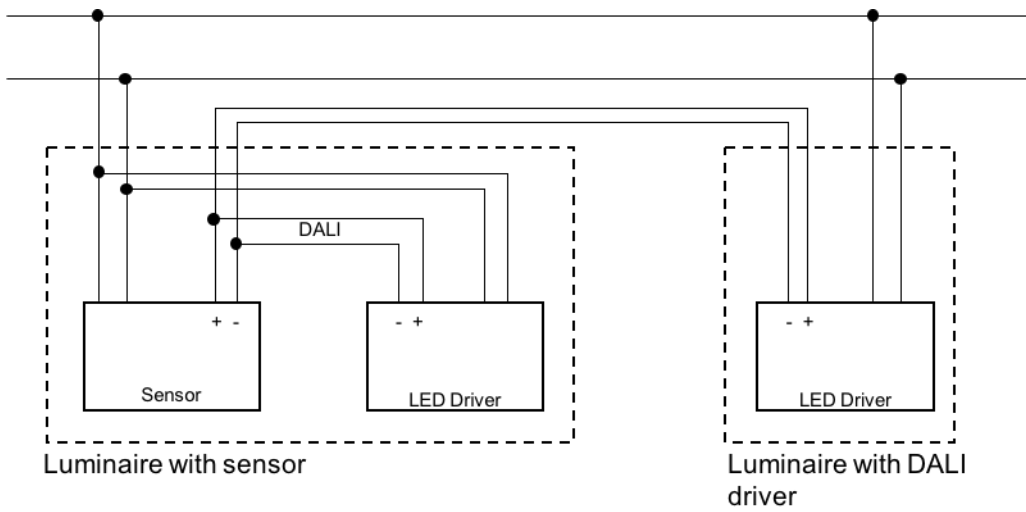

## e-Sense **Move Highbay**

Fagerhult develops, manufactures and markets professional lighting systems for public environments. Our operations are run with a constant focus on design, function, flexibility and energy saving solutions.

Fagerhult is part of the Fagerhult Group, one of Europe's leading lighting groups with operations in more than 15 different countries. AB Fagerhult is listed on the NASDAQ OMX Nordic Exchange in Stockholm.

HEAD OFFICE SWEDEN  
Fagerhults Belysning AB  
SE-566 80 Habo, Sweden  
Tel +46 36 10 85 00  
Fax +46 36 10 86 99  
[www.fagerhult.com](http://www.fagerhult.com)