

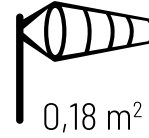

## I-VALO LUKA INSTALLATION INSTRUCTIONS



A  
↑  
G



**FI** Tämä tuote sisältää valonlähteen, jonka energiatehokkuusluokka on **C**.

**SV** Denna produkt innehåller en ljuskälla med energieffektivitetsklass **C**.

**EN** This product contains a light source of energy efficiency class **C**.

**FR** Ce produit contient une source lumineuse de classe d'efficacité énergétique **C**.

**DE** Dieses Produkt enthält eine Lichtquelle der Energieeffizienzklasse **C**.

**PL** Ten produkt zawiera źródło światła o klasie efektywności energetycznej **C**.

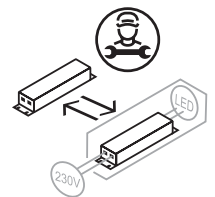
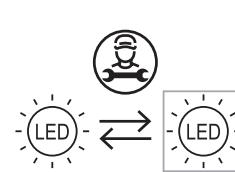

1

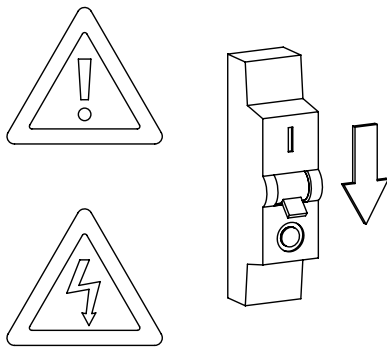

2

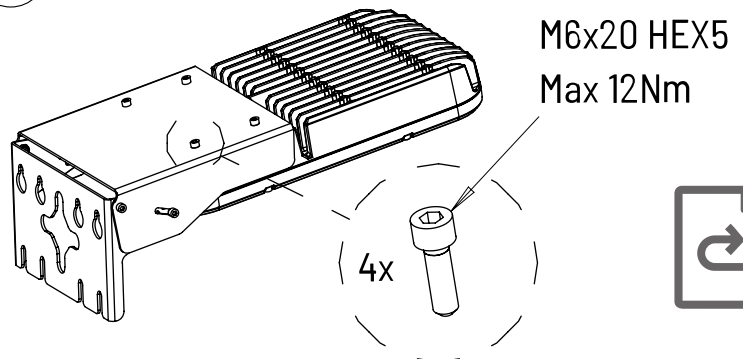

1~

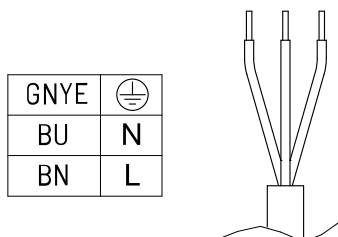

3a

1~ + DALI

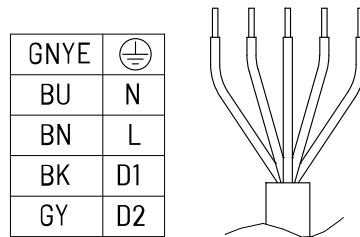

3b

1~ + DALI

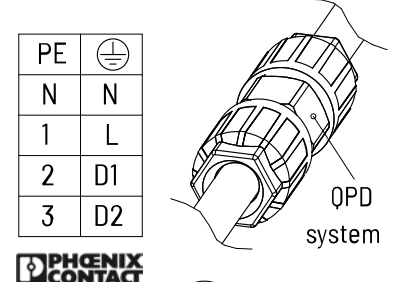

PHENIX CONTACT

3c

